

# USB

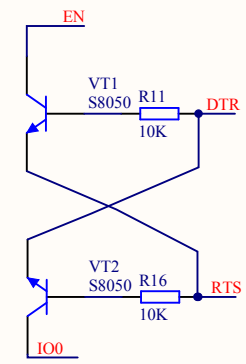
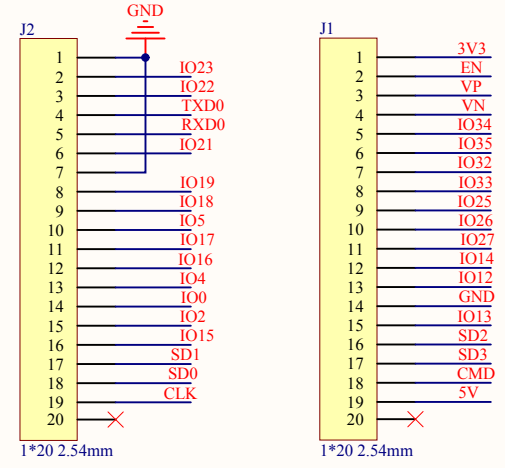
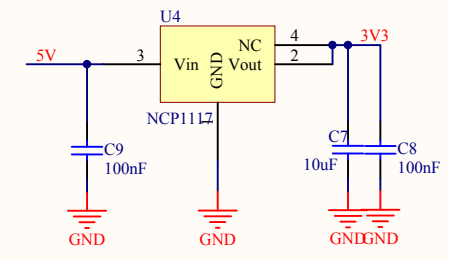
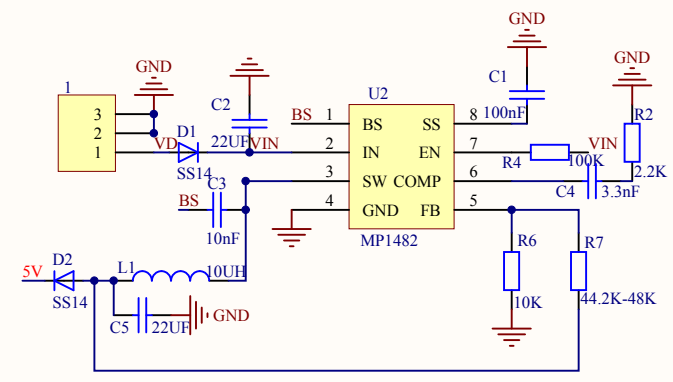
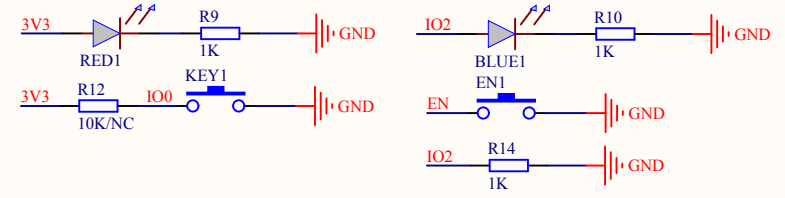
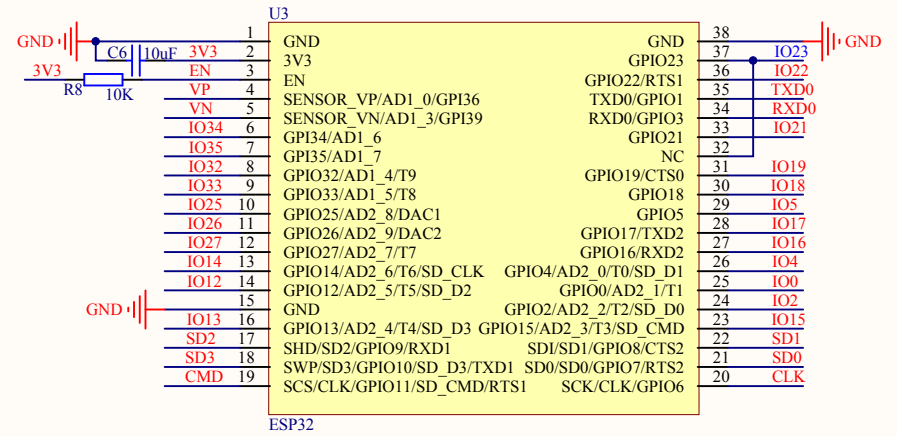
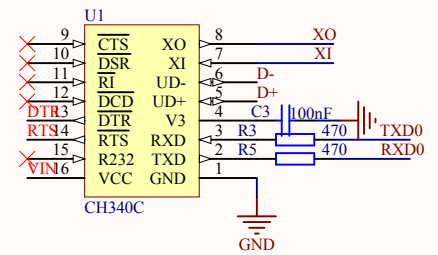
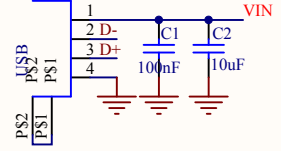

Title		
Size	Number	Revision
A4		
Date:	2017/8/18	Sheet of
File:	D:\WORK\...\CHJ340.SchDoc	Drawn By: